

.....|

|

|

|

..... 3.....ê.

.....

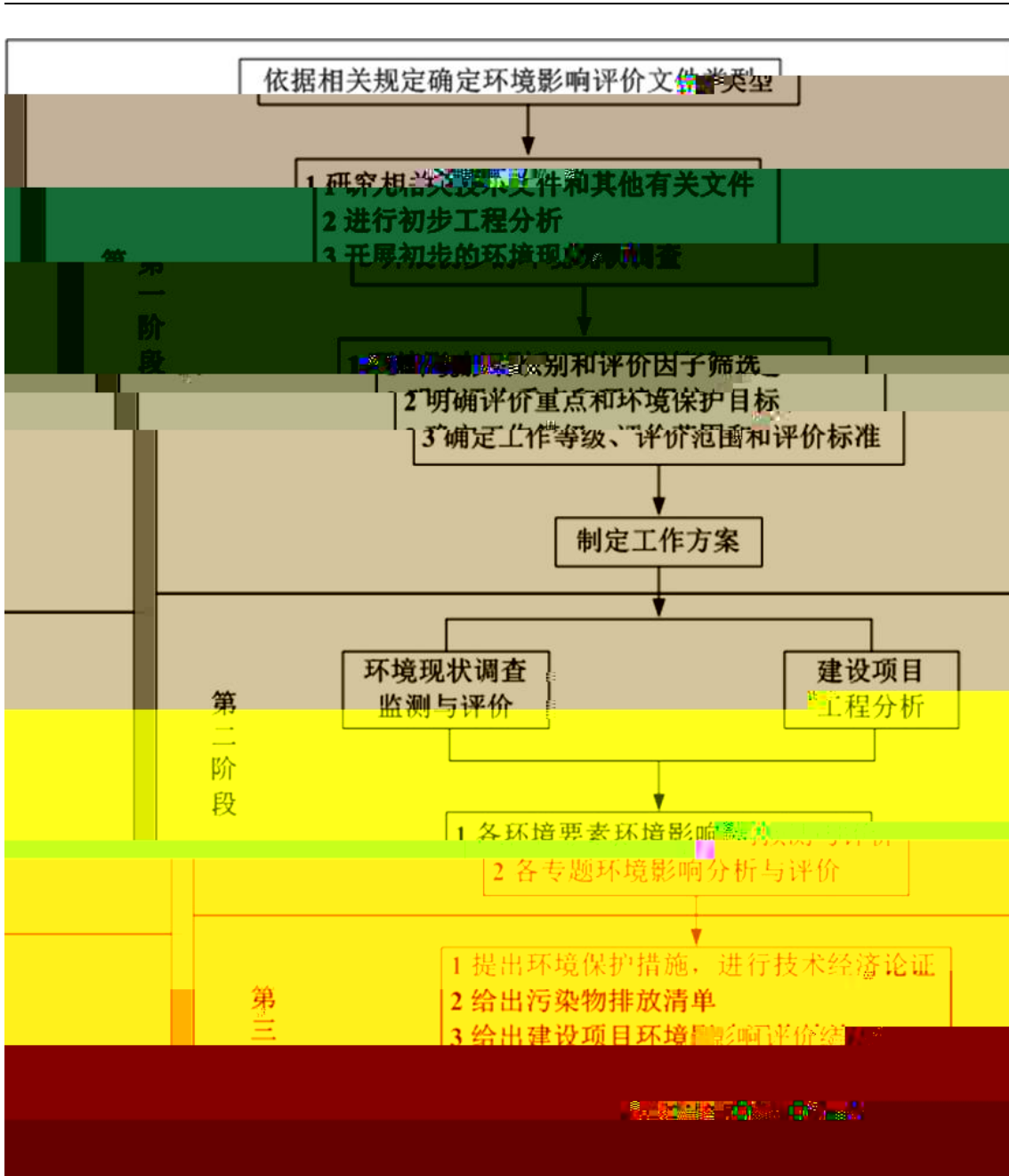



REPORT

--	--	--	--

1、

2、

3、

4、

5、

6、

7、

8、

9、

10、

11、

12、

13、

Ã

16.

17. “_PP &• ,

13、

14、

15、

16、

17、

18、

1、

2、

3、

4、

5、

6、

7、

8、

9、

10、

11、

12、

13、

14、

15、

16、

17、

18、

19、

20、

21、

LOGS, INC. ET AL.,
vs. GOOGLE, INC. ET AL.,

22、

1、

2、

3、

4、

5、

6、

7、



ó í



û wK...p,@÷

z K...p,@÷

/									

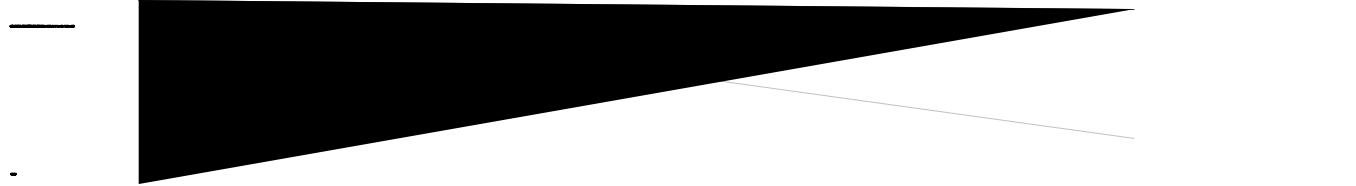

M

S

x #
P & S A E D D T \$! D ö
& " € D % ^

Ð w
ë
+6 ' œ
E ð Õ r ä C
0 & V 7 u é æ Á T ' H \$ æ á

9 & V

X # y S ^ € D ë °



8

- 2 λ 2 v € D ,

v ö E K O E
V H
x

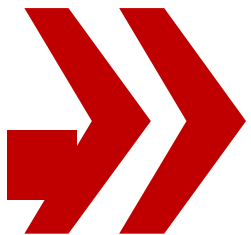

c

w





B)

“人”

5
H

--	--	--	--	--	--

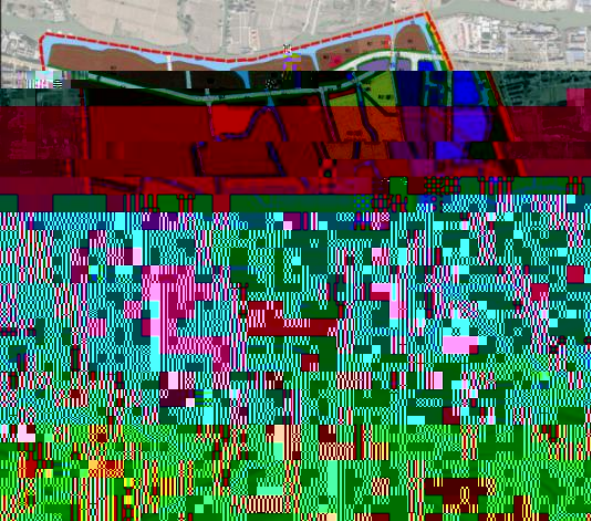



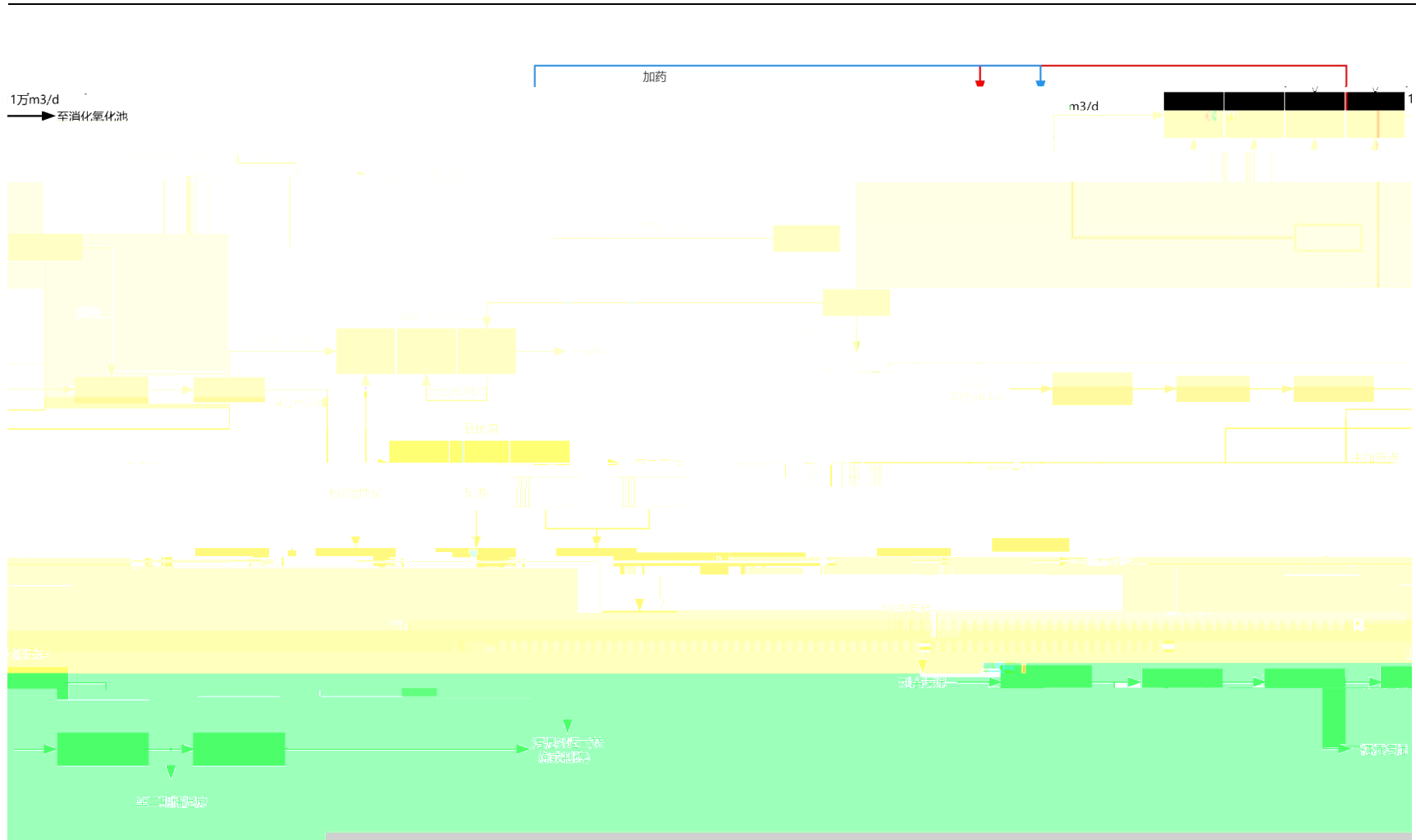

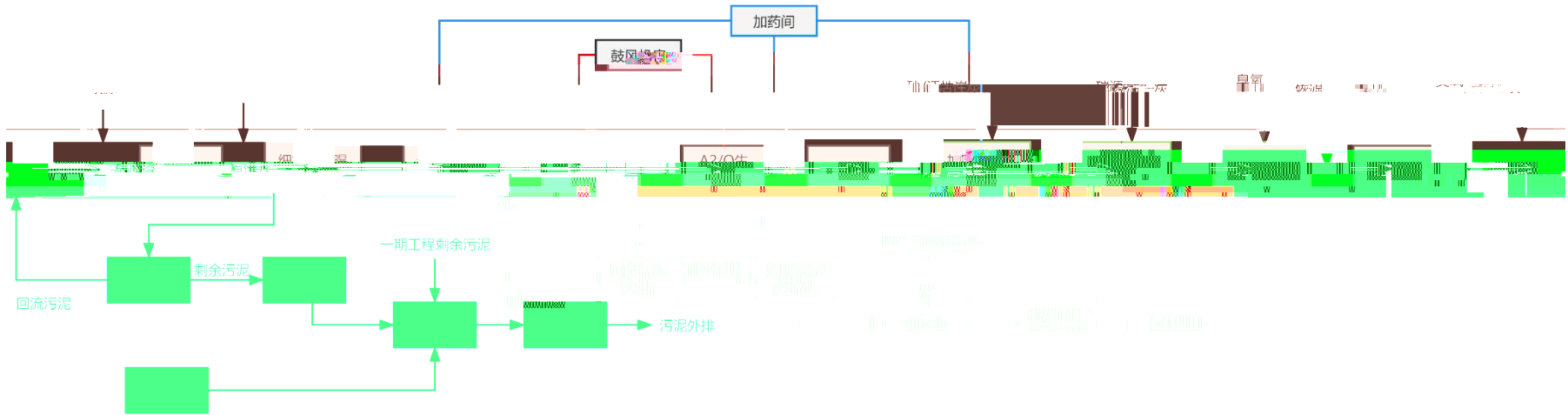

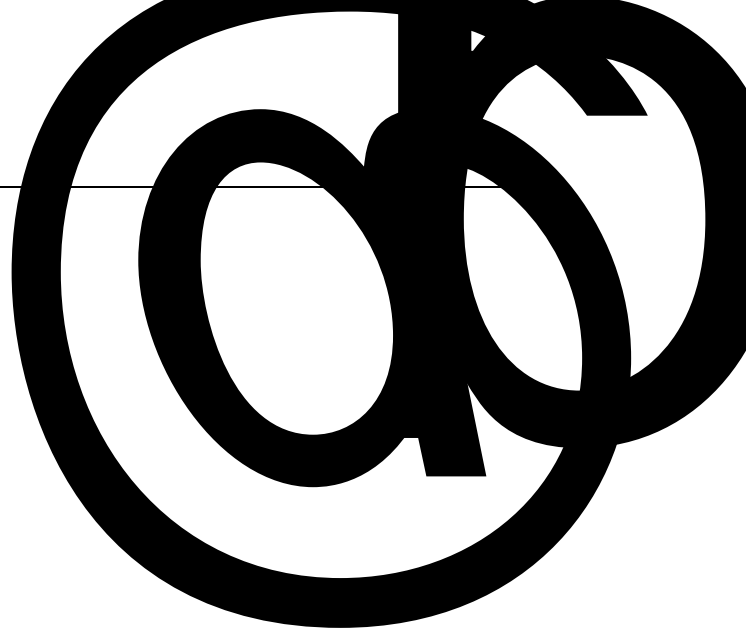
0fæ—ñ0 r`K

Ú



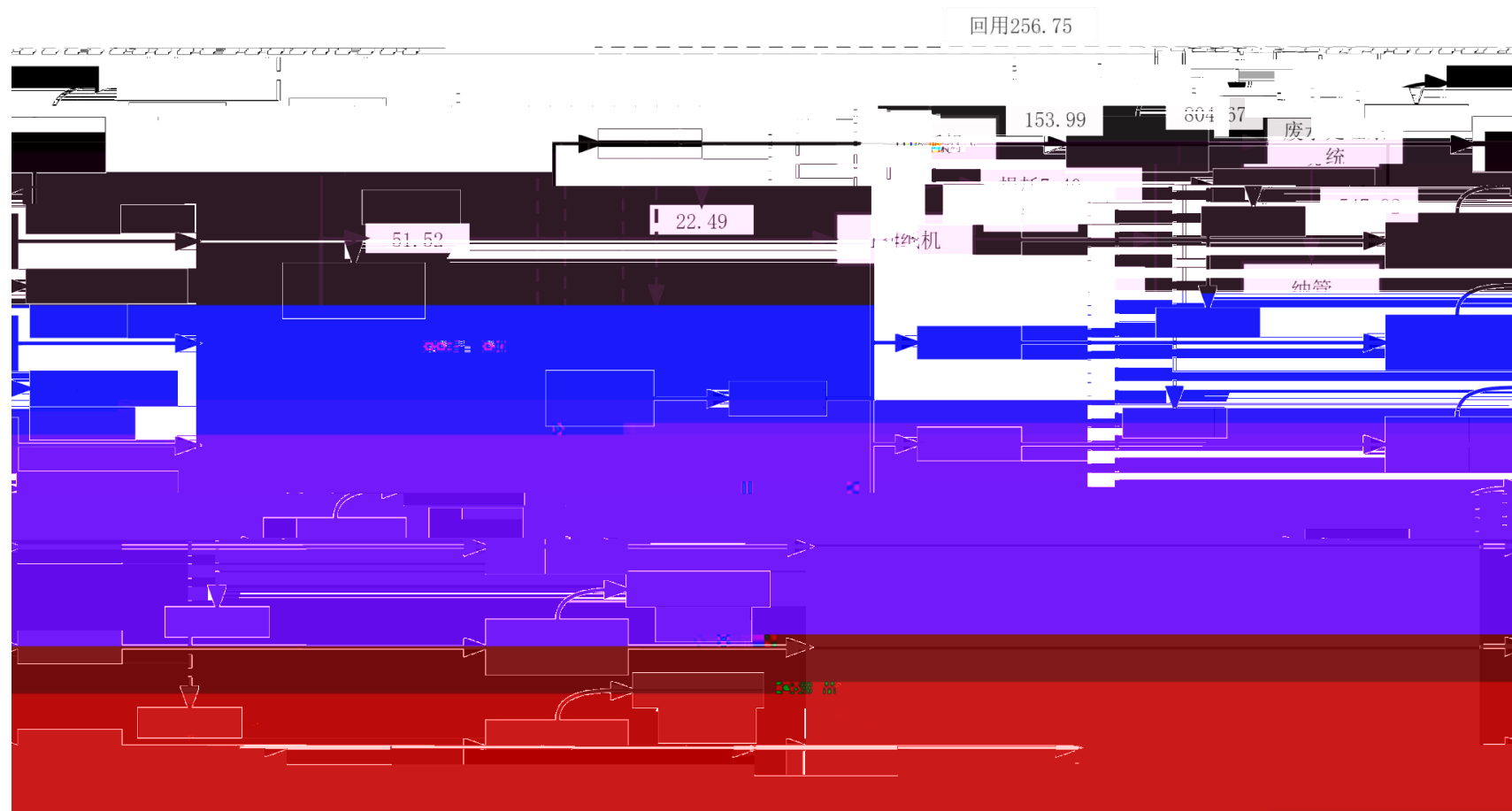

—

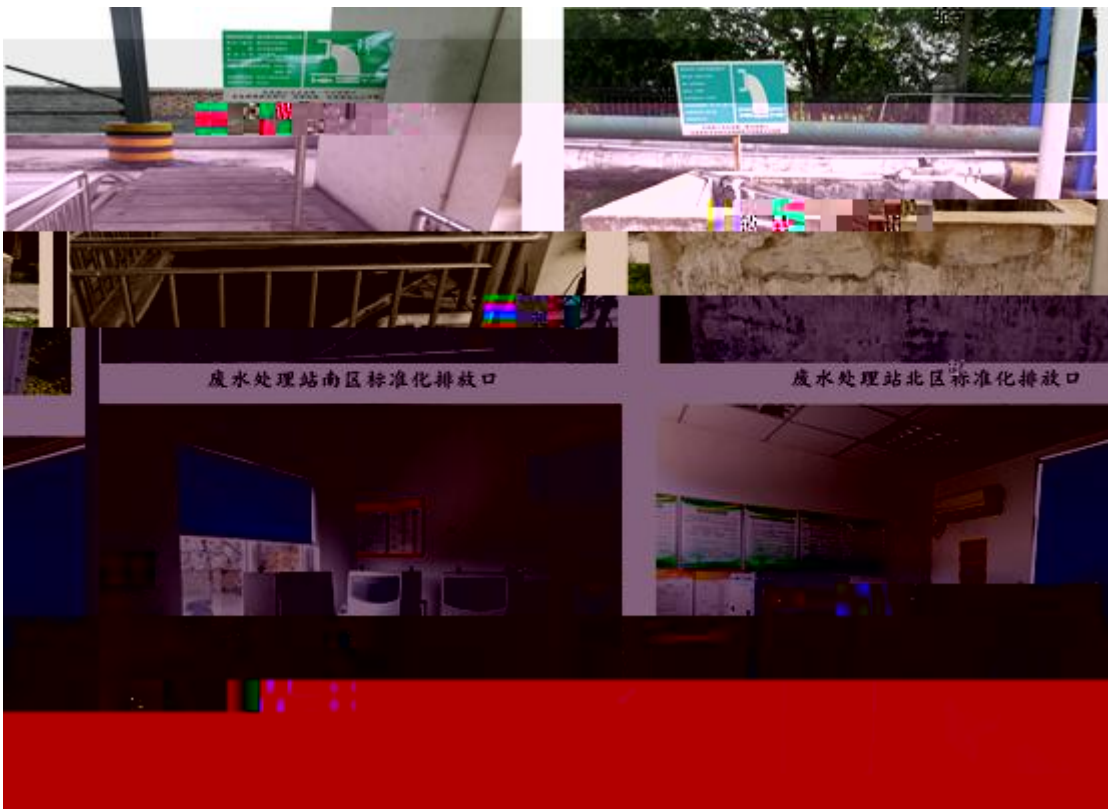

废水处理站南区标准化排放口

废水处理站北区标准化排放口



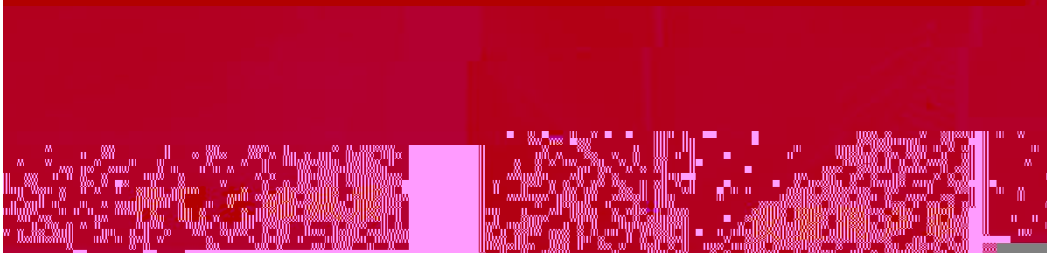

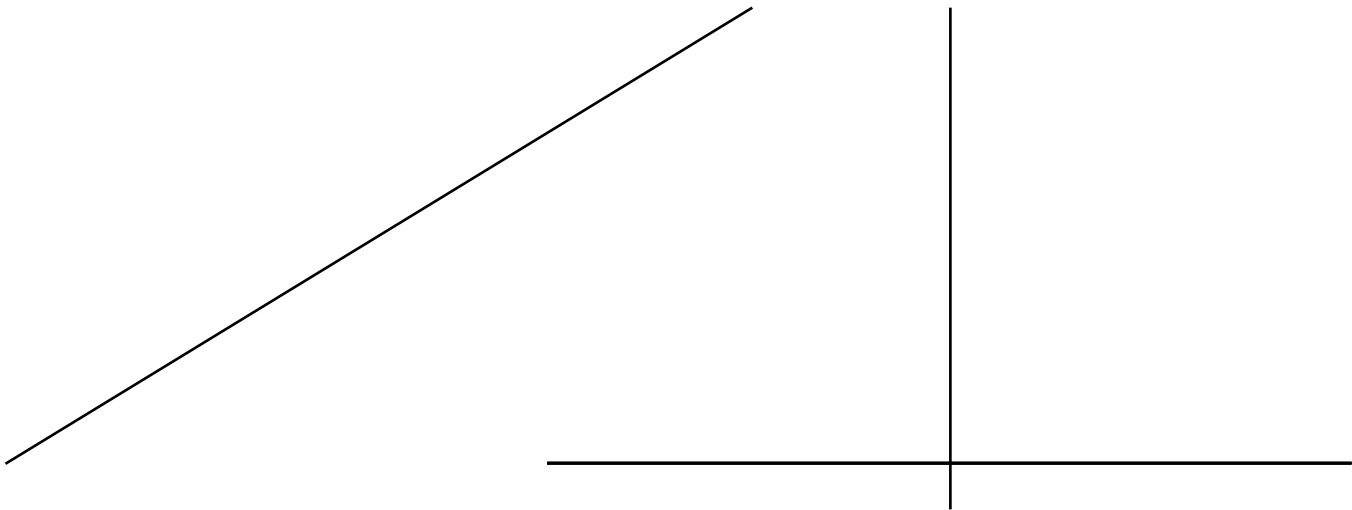





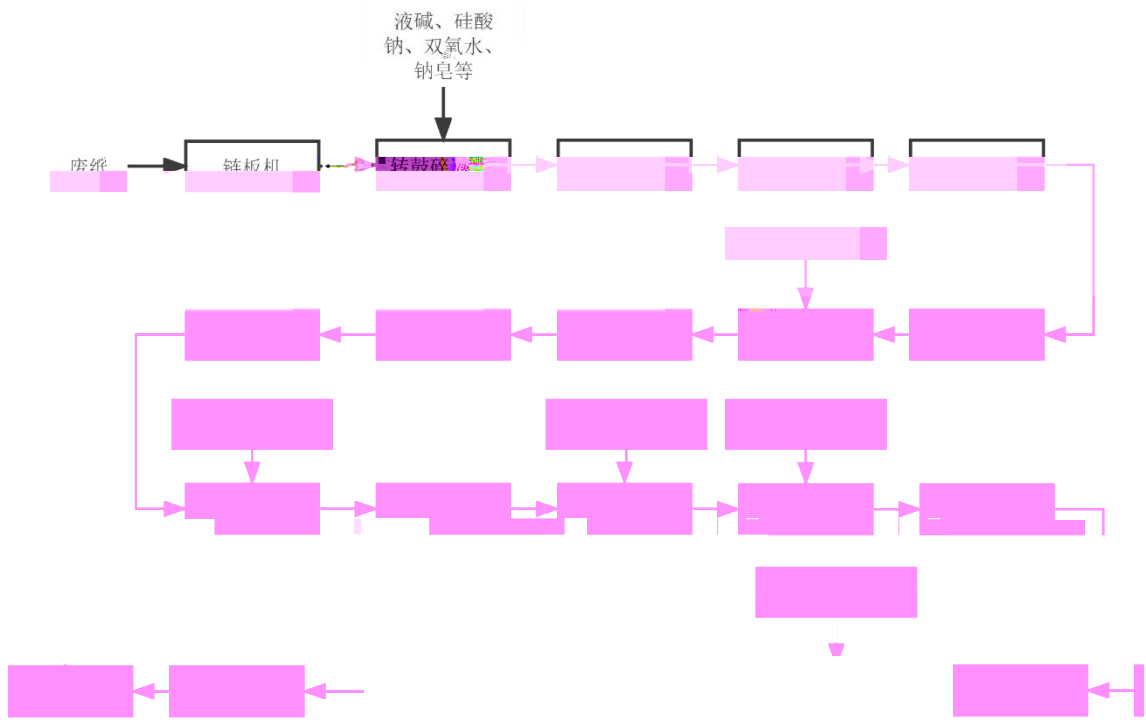

_à

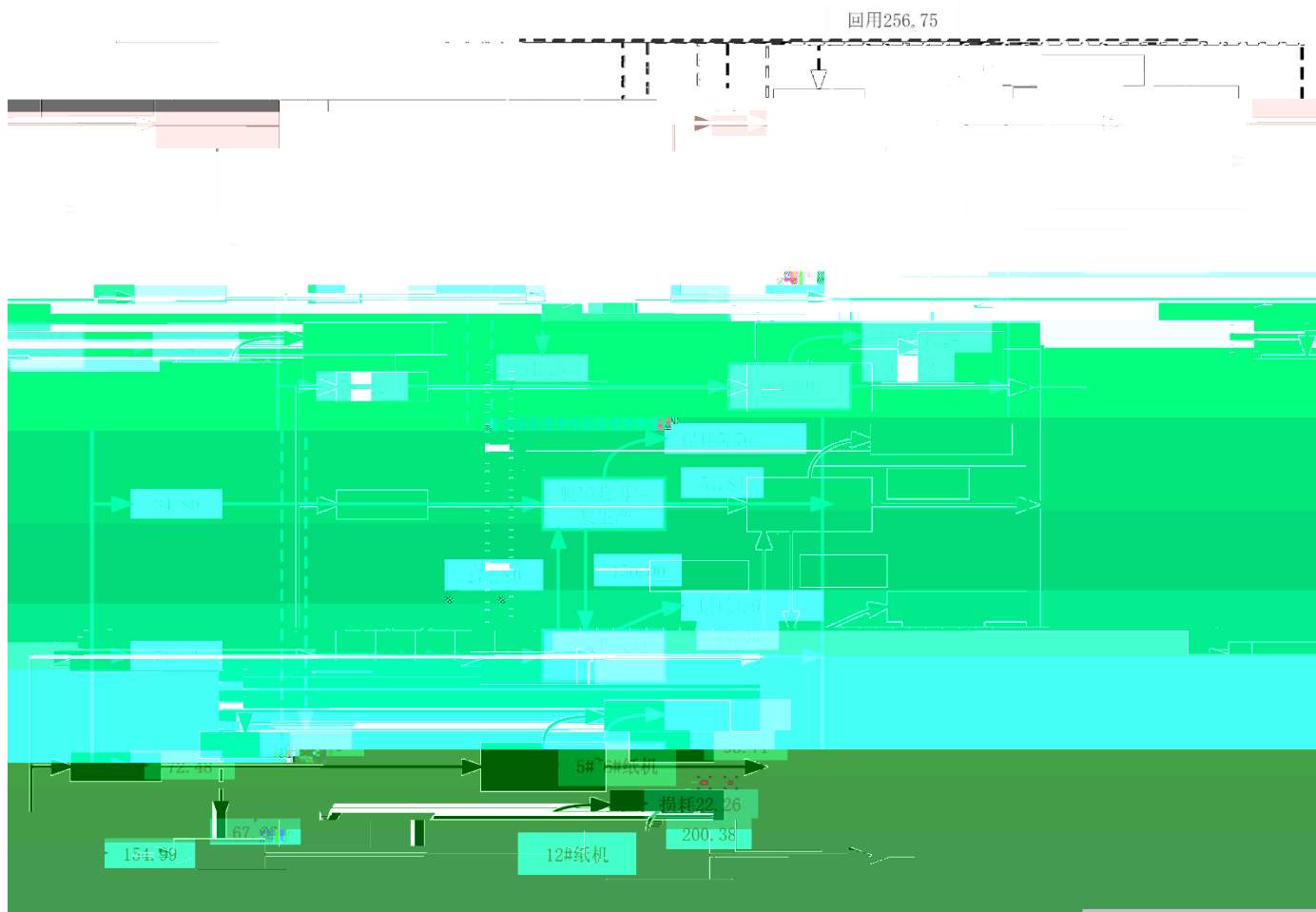

rwef

• H A P T • A T

bae

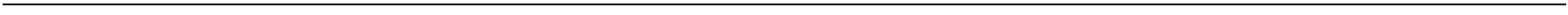

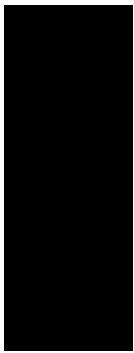

u d

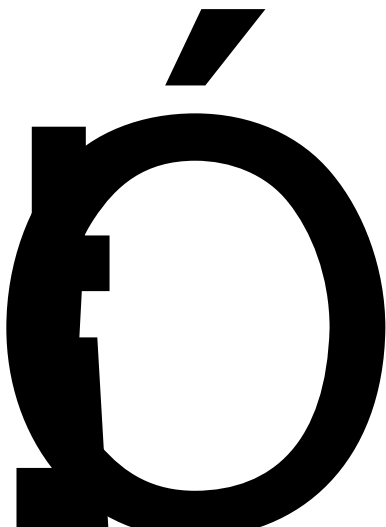

ИЗЗ



T 9

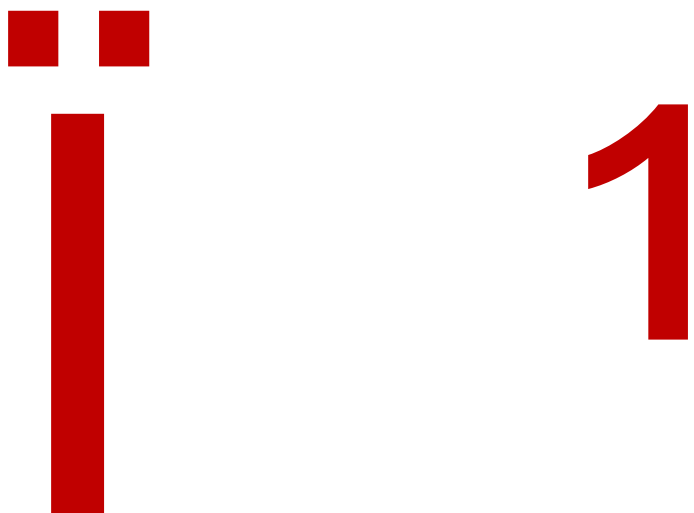
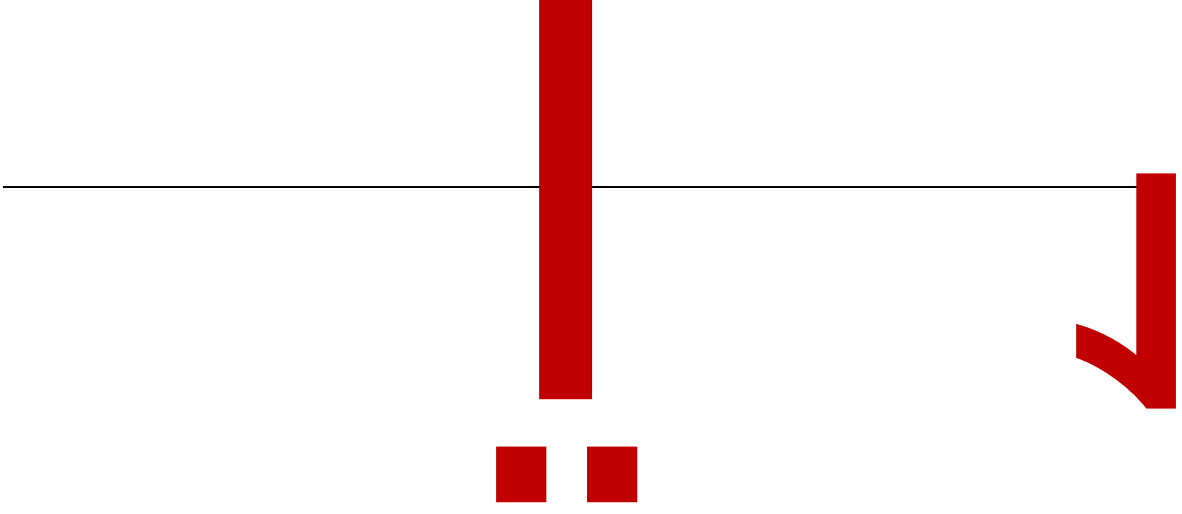





U. TrXo

S



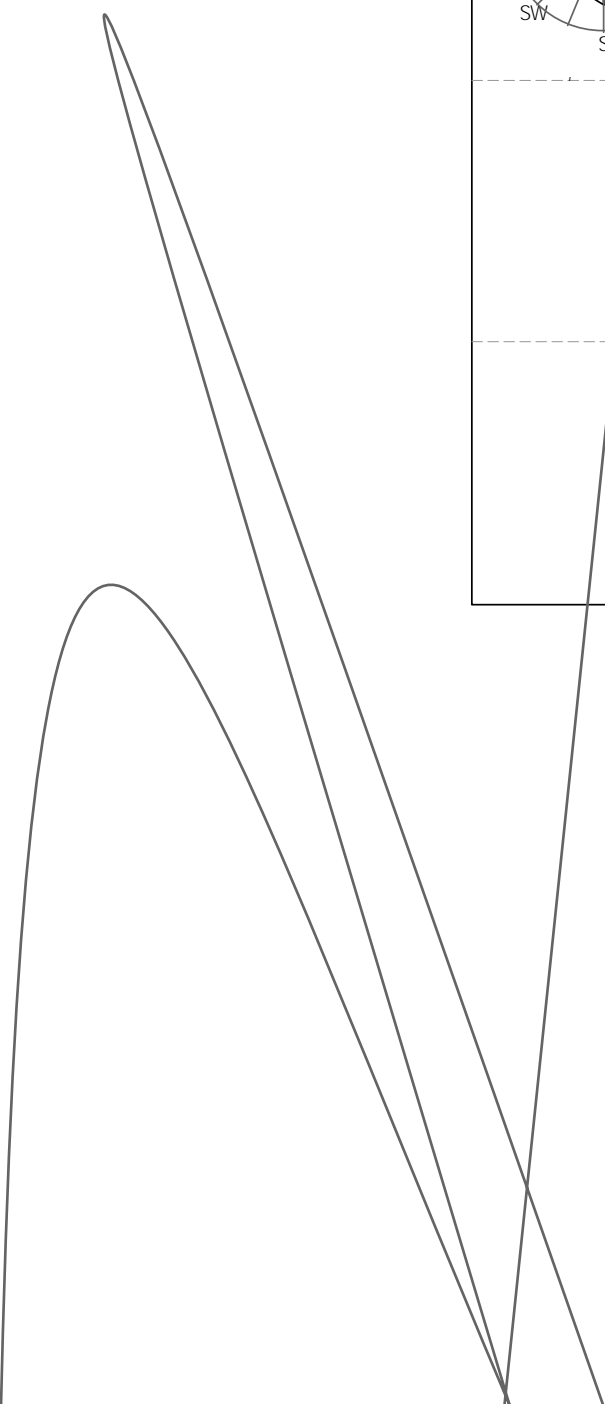
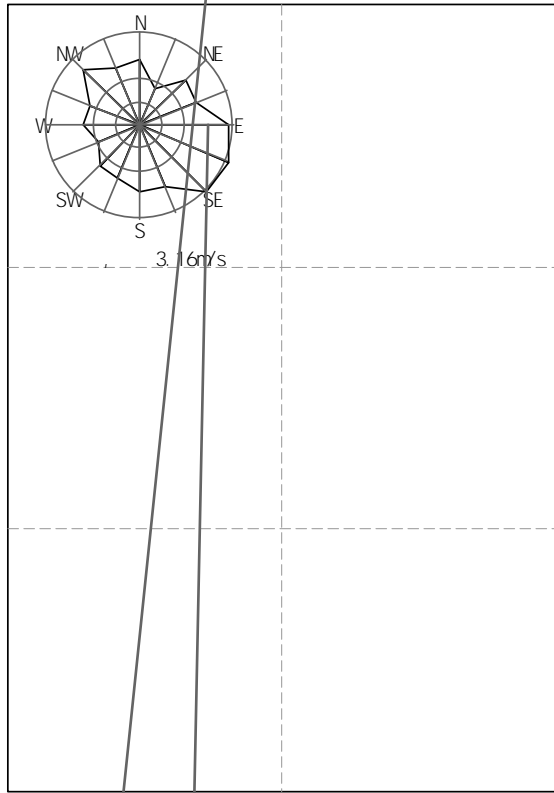

		=50km		5-50km		=5km			
	SO ₂ +NO _x	2000t/a		500-2000t/a		500t/a			
		SO ₂ NO ₂ PM ₁₀ PM _{2.5} CO O ₃		PM _{2.5} PM _{2.5}					
				D					
		2021							
		AERMOD	ADM5	AUSTAL2	EDMS/AEDT	CALPUF			
		D		000		F			
		50km		5-50km		=5km			
						PM _{2.5} PM _{2.5}			
		C		100%		C 100%			
			C	10%		C 10%			
			C	30%		C 30%			
	1h	h		c 100%		c 100%			
		C				C			
		k -20%				k -20%			
		m							
		SO ₂	t/a	NO _x	t/a	t/a	VOCs	t/a	
		"	"	"	"	"	"	"	"

DEV J DEV 7000 ó ó çh
» »
‡ »

> 2 €00, 03 2H9 0 €0 D 220, 0 €0 0B 00 P 217 8P €0 8

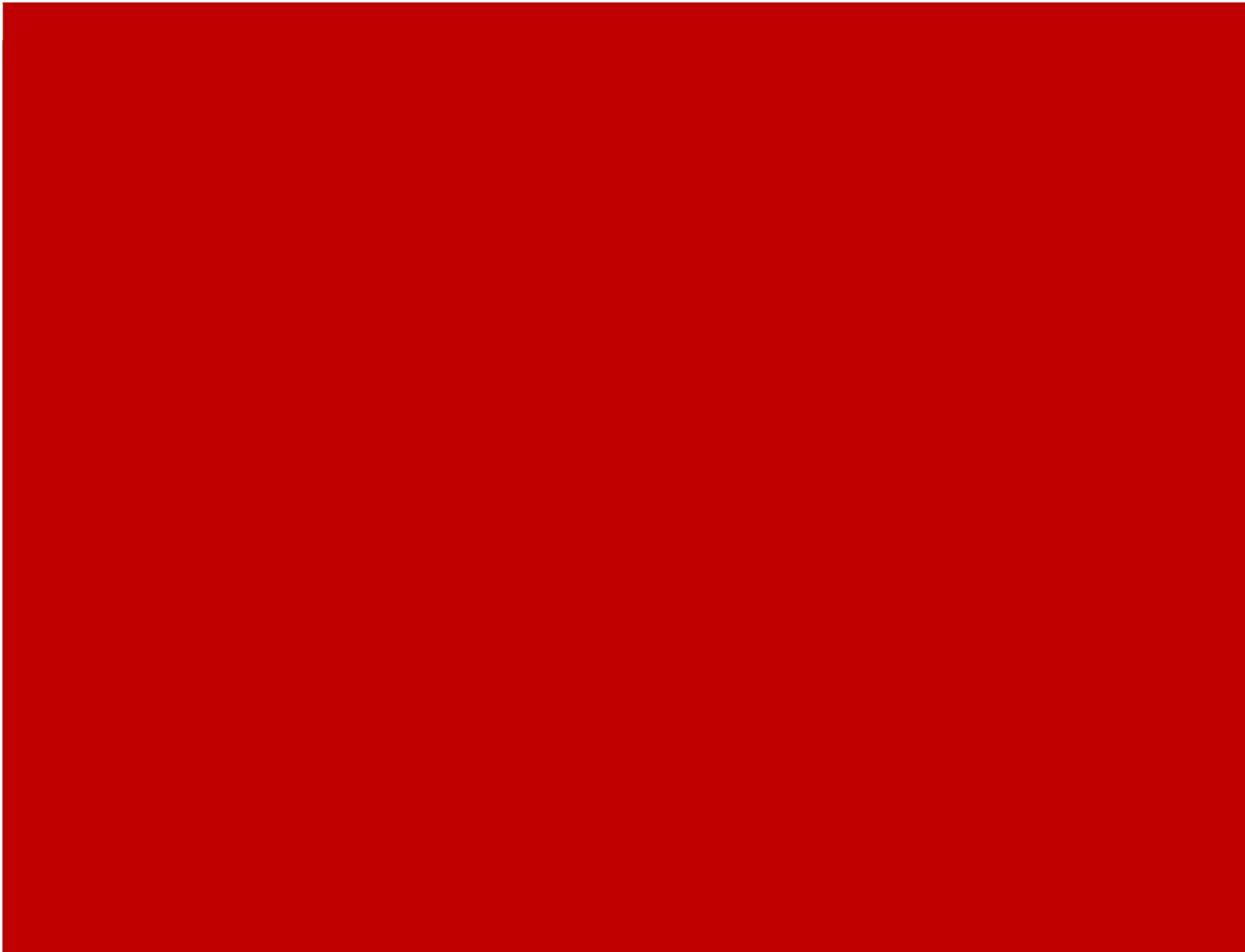

pH

		km	km ²

工程地质剖面图 5—5'

比例尺：水平：1:150 垂直：1:200

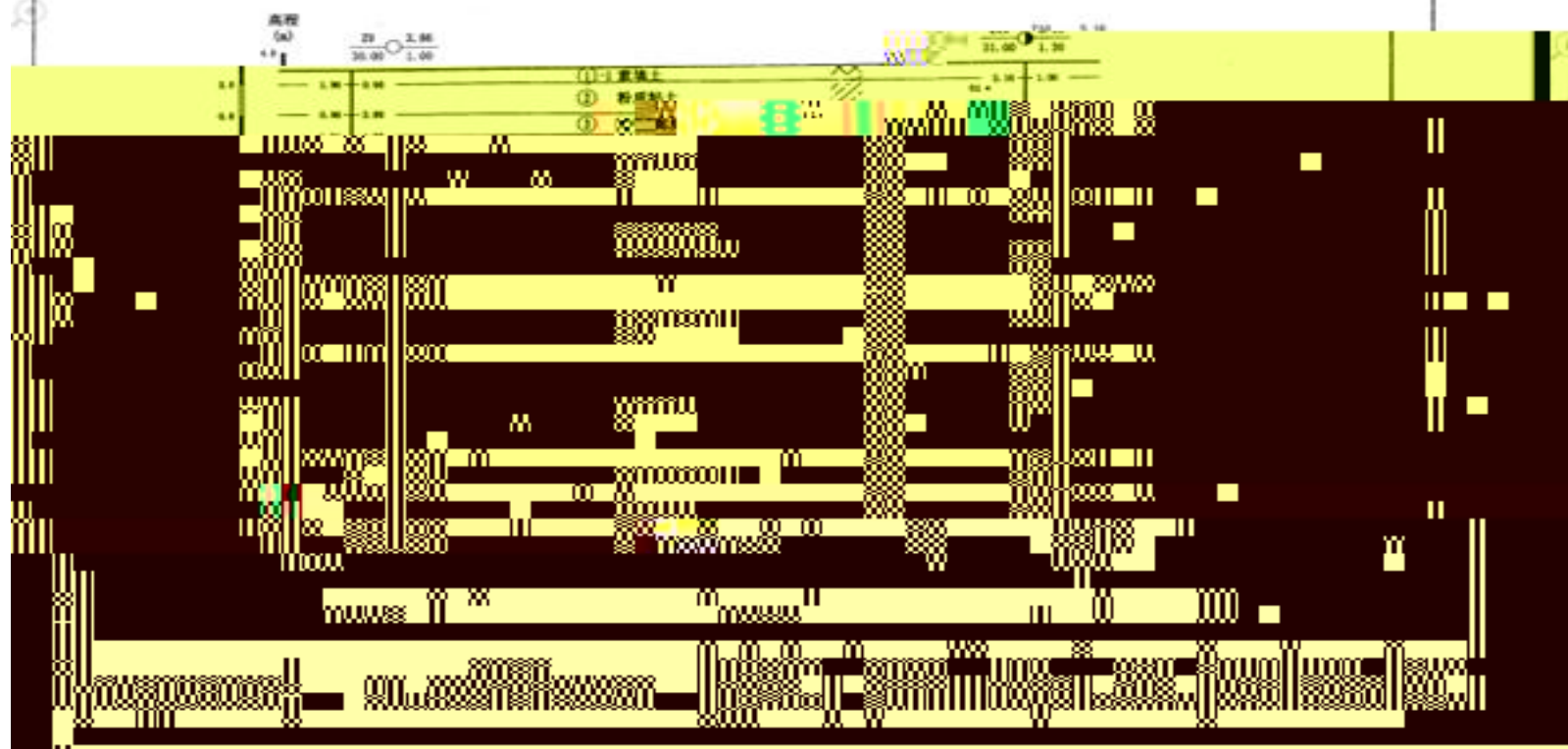

OB



o

$$\frac{C}{C_0} = \frac{1}{2} \operatorname{erfc}\left(\frac{x-ut}{2\sqrt{D_L t}}\right) + \frac{1}{2} e^{\frac{ux}{D_L}} \operatorname{erfc}\left(\frac{x+ut}{2\sqrt{D_L t}}\right)$$



!%&'()*+,-./:;<=>?@A B C D E F G H I J K L M N O P Q R S T U V W X Y Z [\] ^ _ ` a b c d e f g h i j k l m n o p q r s t u v w x y z 0 1 2 3 4 5 6 7 8 9 ! " # \$ % & ' () * + , - . / : ; < = > ? @ A B C D E F G H I J K L M N O P Q R S T U V W X Y Z [\] ^ _ ` a b c d e f g h i j k l m n o p q r s t u v w x y z 0 1 2 3 4 5 6 7 8 9



$$L_{oct} T = \left[\sum_{i=1}^N L_{oct i} \right]$$

$$L_{oct} T = L_{oct} T - TL_{oct} +$$

$$L_{w oct} = L_{oct} T + S$$

$$Leq T = \left(\frac{1}{T} \right) \left[\sum_{i=1}^N t_{in i}^{L_A in i} + \sum_{j=1}^M t_{out j}^{L_A out j} \right]$$





0dB2` r2N • 3

P





“

È ½ h

” B

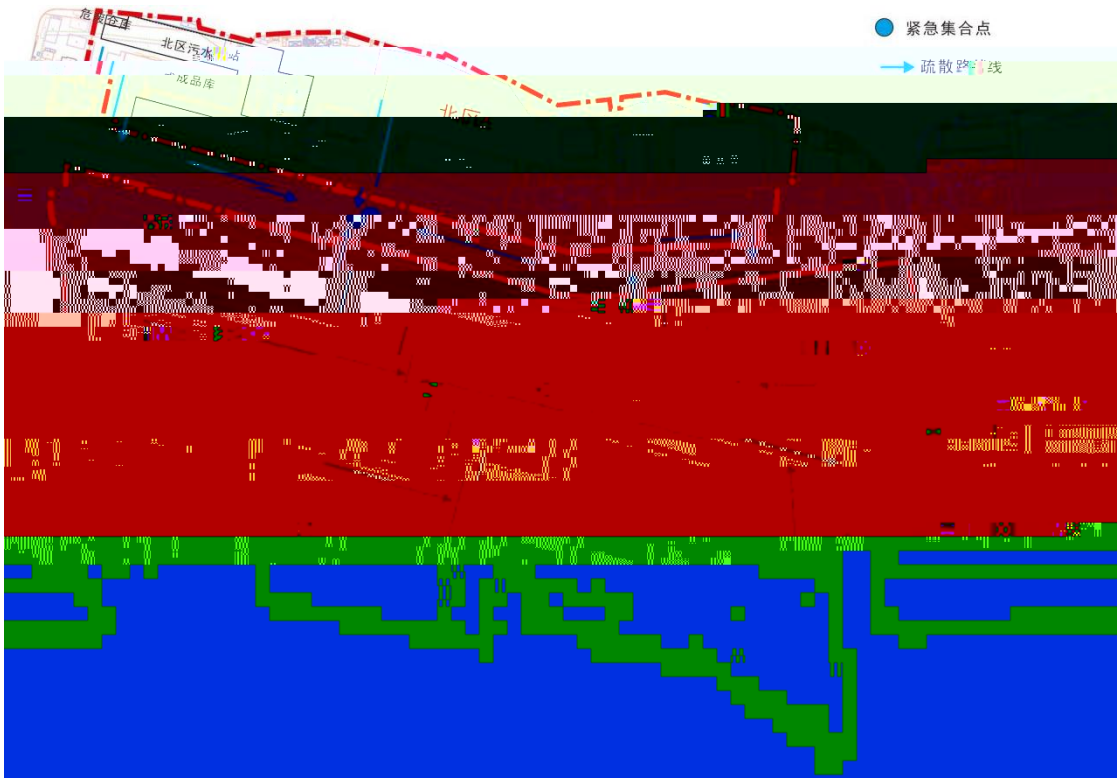

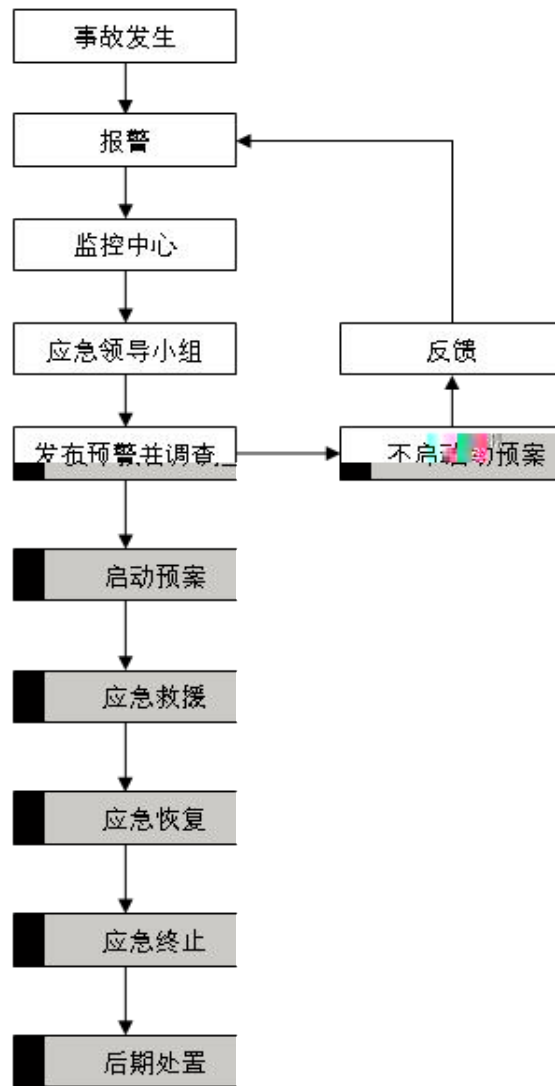

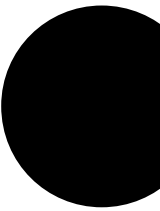

+

§

—

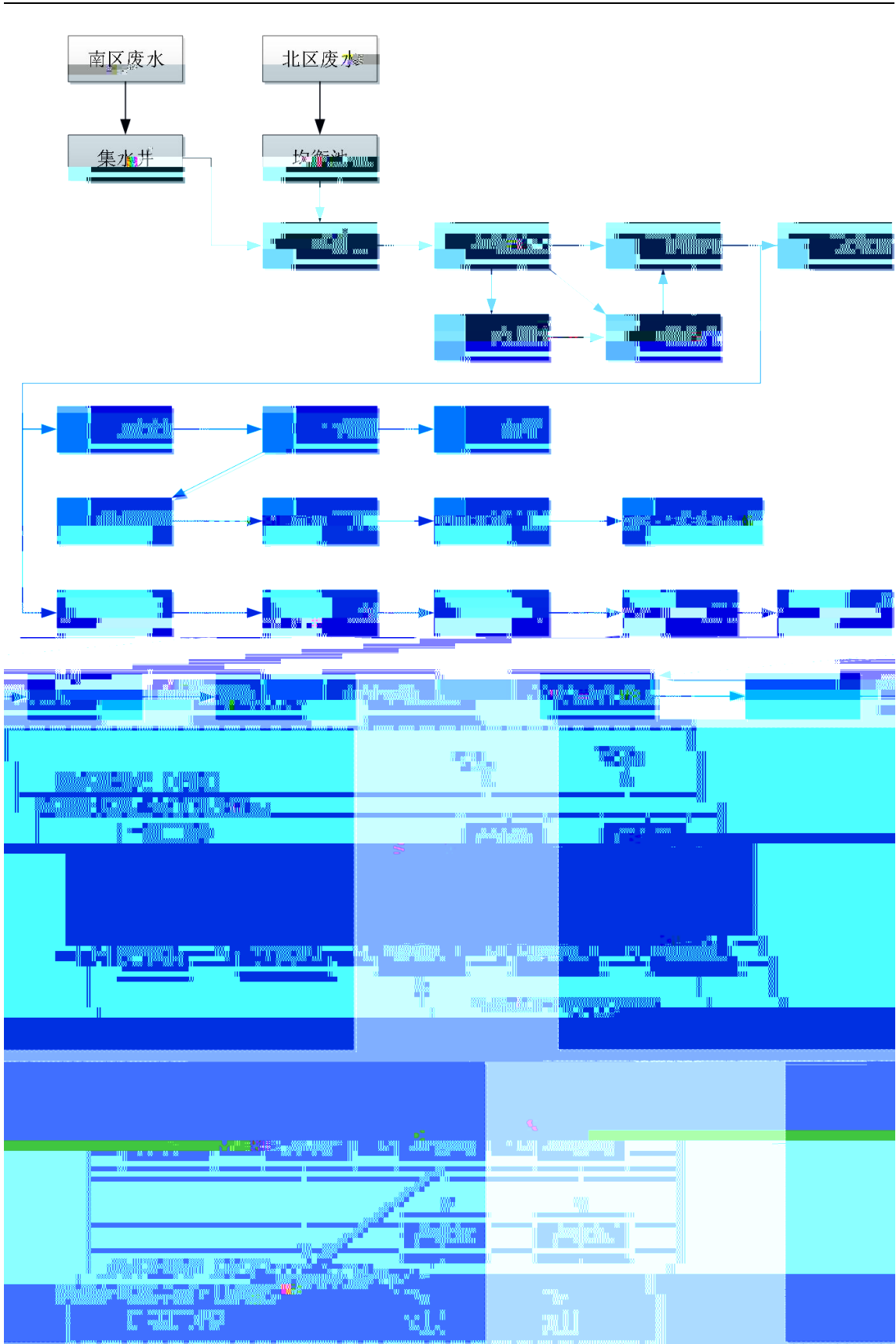

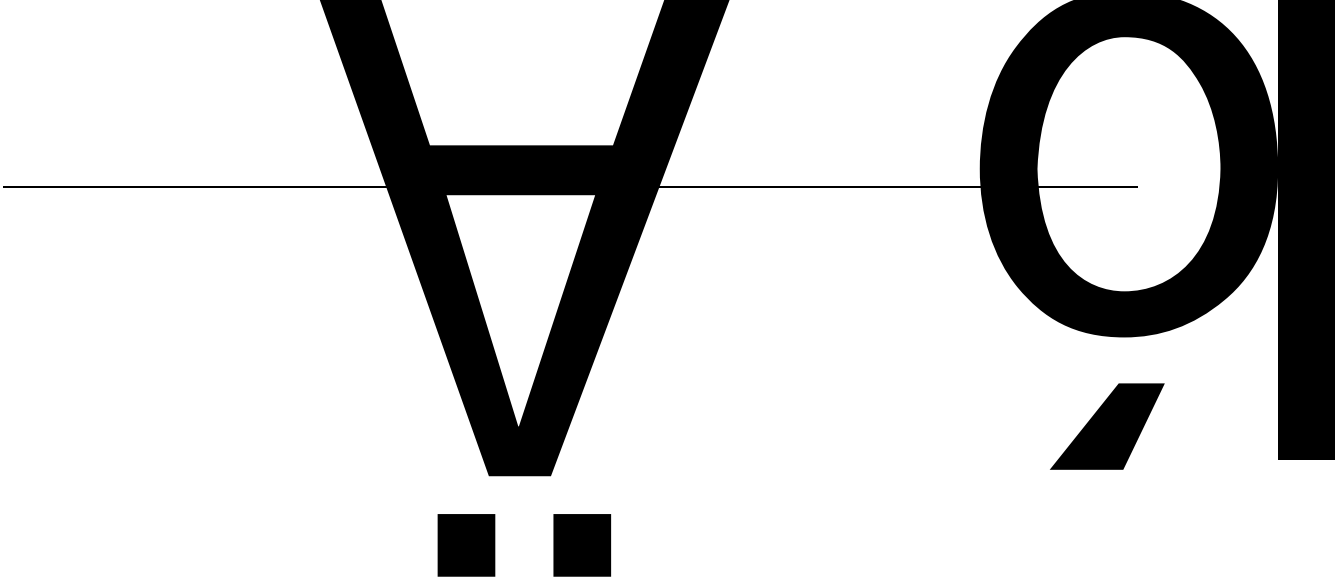

C

"

$$HI = \frac{ET}{\dots} \times 100\%$$

IEP • B LWC -

*

"

l E



B



\$ \$ Q

B 0/90

7th / 10/10/2024

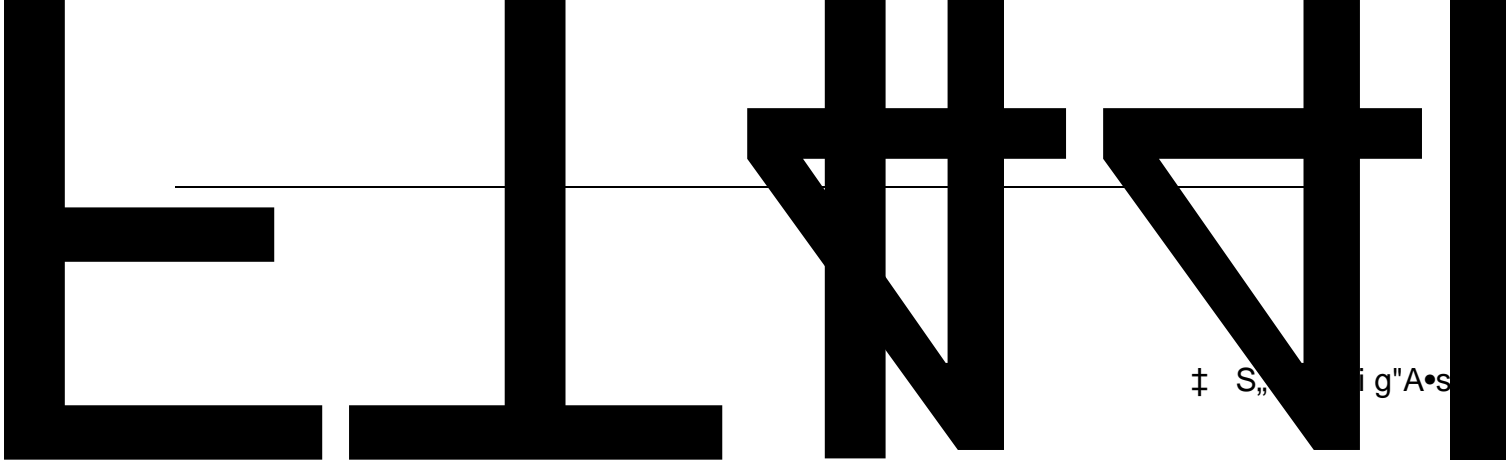

‡ S, i g"A•s \$ E

ì “ Å \$ & \$ Å @ i ^

